

## Black Tulip

The Black Tulip changes from colour according to the reflection of ambient light. The colour changes from black to burgundy (red) colour. The Black Tulip switch can surprise you on every moment of the day with its colour.

### SB4T

Li13112 (24 V), Li13212 (24 V + LED), Li13312 (250 V push button), Li13412 (250 V, mech. switch)

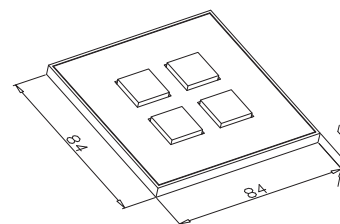
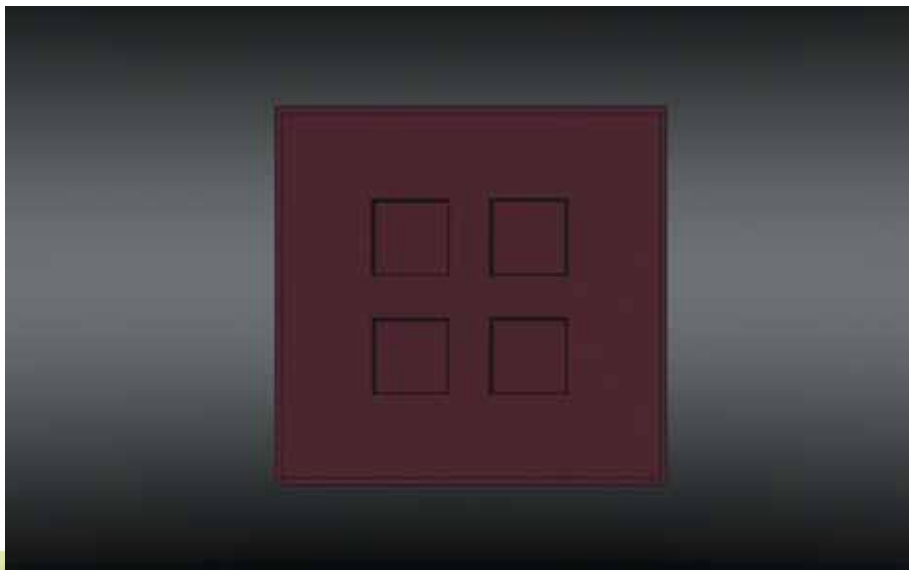

24 V pb: Max. 25 mA  
250 V pb: Max. 1 A  
250 V mech. switches: Max. 3 A

**Accessories:** Plaster kit

**Parts included:**

- frame
- cover plate
- mounting frame
- hook
- buttons

**Optional parts:**

- 250 V pb: protection frame, clamps
- 24 V + LED: connector, spacer, LED
- mech. switch: protection frame

Mech. switches : wall boxes (depth 65mm) included

IP  
41



### SBMG

Li31512 (Bticino frame), Li31612 (Legrand / Hager / Peha frame)

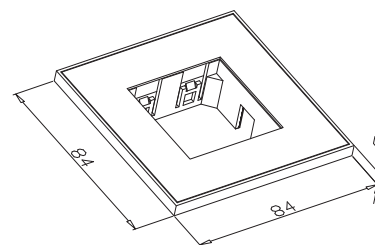
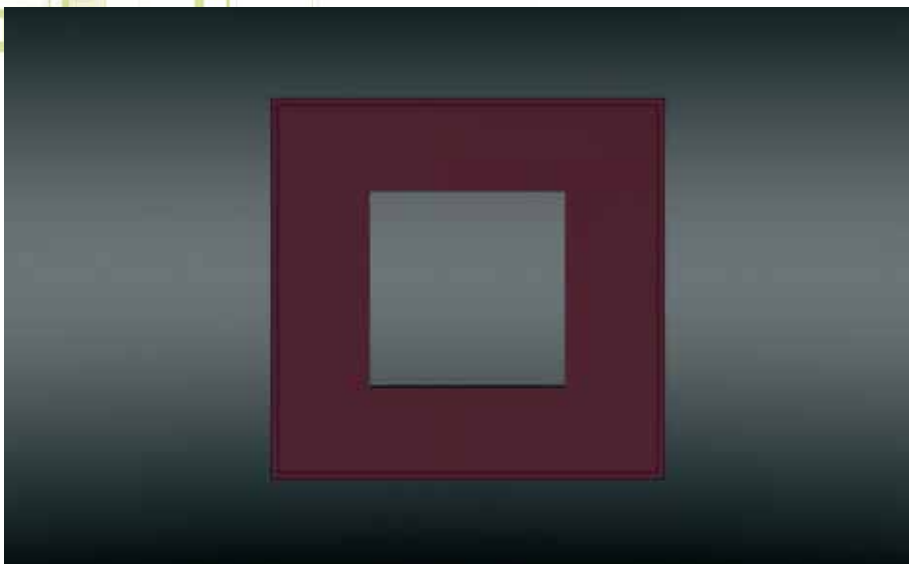

**Accessories:** Plaster kit

**Parts included:**

- frame
- cover plate
- mounting frame
- hook

For mounting max. 2 modules.

IP  
41



# Black Tulip

Available in:

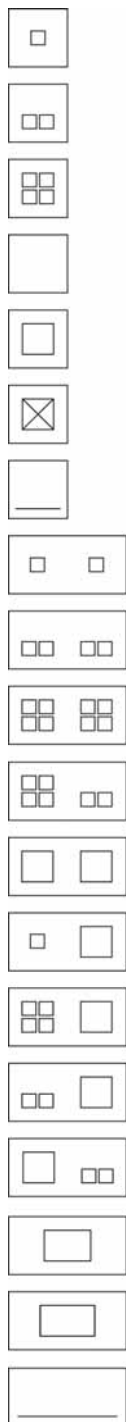

Article group	24 V version	24 V + LED	250 V push button	250 V mech. switch	250 V modules
B	Li11112	Li11212	Li11312	Li11412	
L/H/P	Li12112	Li12212	Li12312	Li12412	
B	Li13112	Li13212	Li13312	Li13412	
L/H/P	SBMK				Li33512 Li33612
B	SBMG				Li31512 Li31612
L/H/P	SBQL				White Li37012 Blue Li38012
	SBB2M				Li35012
	SB11T	Li14112	Li14212	Li14312	Li14412
	SB22T	Li15112	Li15212	Li15312	Li15412
	SB44T	Li16112	Li16212	Li16312	Li16412
	SB42T	Li21112	Li21212	Li21312	Li21412
B	SBMMG				Li32512 Li32612
L/H/P	SB1TMG	Li17A12 Li17G12	Li17B12 Li17H12	Li17C12 Li17I12	Li17D12 Li17J12
B	SB4TMG	Li20A12 Li20G12	Li20B12 Li20H12	Li20C12 Li20I12	Li20D12 Li20J12
L/H/P	SB2TMGR	Li18A12 Li18G12	Li18B12 Li18H12	Li18C12 Li18I12	Li18D12 Li18J12
B	SB2TMGL	Li19A12 Li19G12	Li19B12 Li19H12	Li19C12 Li19I12	Li19D12 Li19J12
L/H/P	SB4MT				Li30512
	SB3MT				Li34512
	SBB22M				Li36012

B = Bticino frame  
L/H/P = Legrand / Hager / Peha frame



## Soft Touch RAL9010

The Soft Touch is standard available in the colour RAL9010. This finishing is soft as velvet. The coverplate and button(s) feel very soft and are a caress for your fingertips. You can feel the soft difference with our standard RAL9010.

### SB2T

Li12110 (24 V), Li12210 (24 V + LED), Li12310 (250 V push button), Li12410 (250 V, mech. switch)

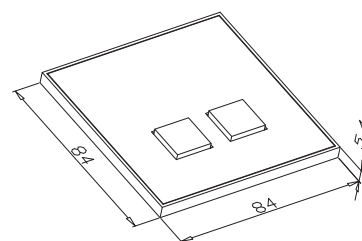
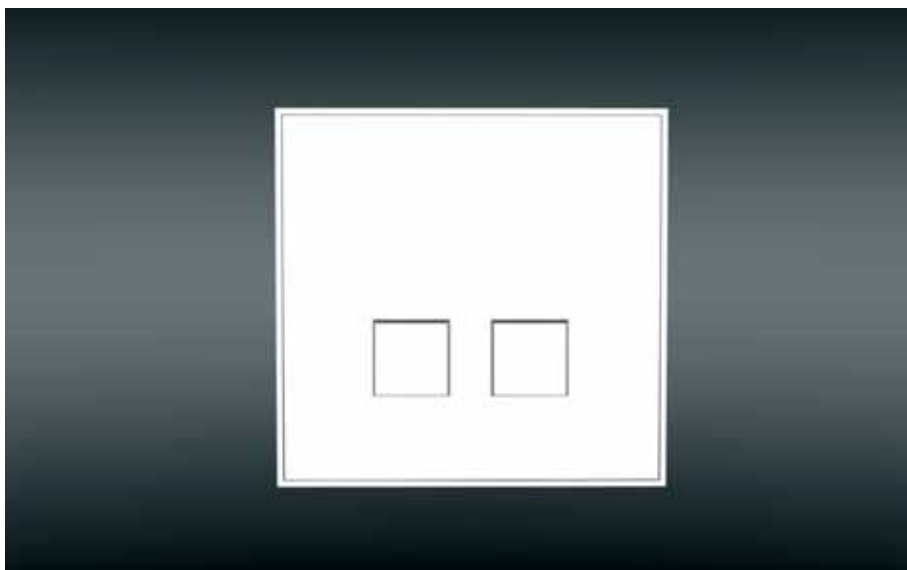

24 V pb: Max. 25 mA  
250 V pb: Max. 1 A  
250 V mech. switches: Max. 3 A

#### Accessories: Plaster kit

#### Parts included:

- frame
- cover plate
- mounting frame
- hook
- buttons

#### Optional parts:

- 250 V pb: protection frame, clamps
- 24 V + LED: connector, spacer, LED
- mech. switch: protection frame

Mech. switches : wall boxes (depth 65mm) included

IP  
41



### SB4TMG

Bticino frame : Li20A10 (24 V), Li20B10 (24 V + LED), Li20Co3 (250 V, push button), Li20D10 (250 V, mech. switch)

Legrand / Hager / Peha frame : Li20G10 (24 V), Li20H10 (24 V + LED), Li20I10 (250 V, push button), Li20J10 (250 V, mech. switch)

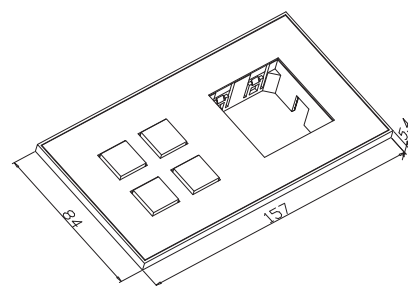
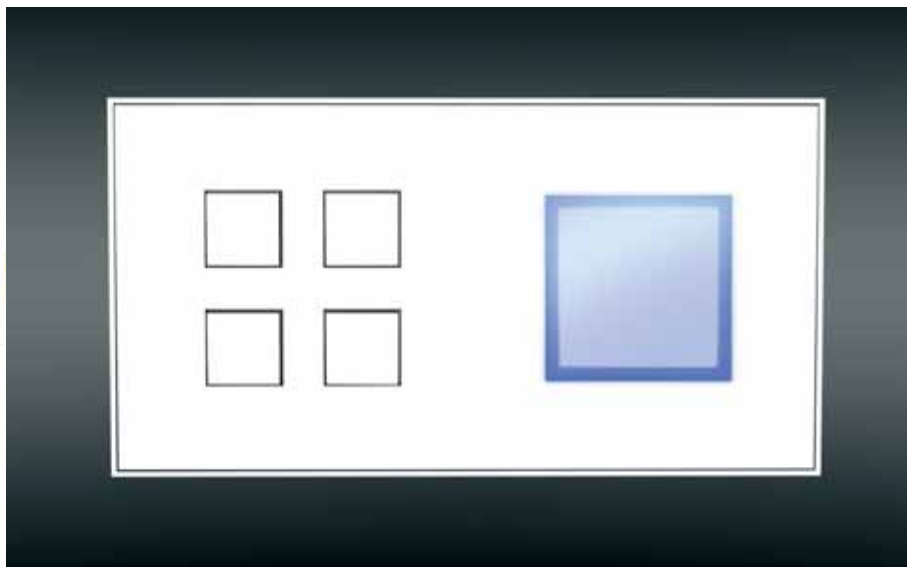

24 V pb: Max. 25 mA  
250 V pb: Max. 1 A  
250 V mech. switches: Max. 3 A

#### Accessories: Plaster kit

#### Parts included:

- frame
- cover plate
- mounting frame
- hook
- buttons

#### Optional parts:

- 250 V pb: protection frame, clamps
- 24 V + LED: connector, spacer, LED
- mech. switch: protection frame

Mech. switches : wall boxes (depth 65mm) included  
For mounting max. 2 modules.

IP  
41



# Soft Touch RAL9010

Available in:

Article group    24 V version    24 V + LED    250 V push button    250 V mech. switch    250 V modules

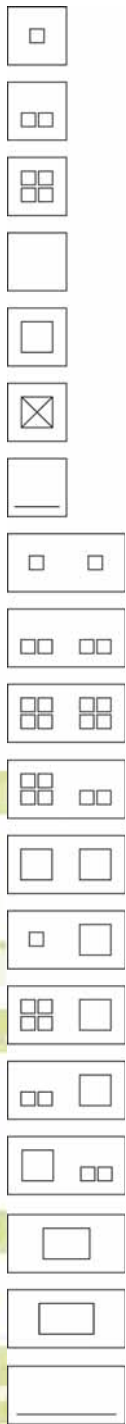

B  
L/H/P

B  
L/H/P

B  
L/H/P

B  
L/H/P

B  
L/H/P

B  
L/H/P

B  
L/H/P

SB1T	Li11110	Li11210	Li11310	Li11410	
SB2T	Li12110	Li12210	Li12310	Li12410	
SB4T	Li13110	Li13210	Li13310	Li13410	
SBMK					Li33510 Li33610
SBMG					Li31510 Li31610
SBQL					White Li37010 Blue Li38010
SBB2M					Li35010
SB11T	Li14110	Li14210	Li14310	Li14410	
SB22T	Li15110	Li15210	Li15310	Li15410	
SB44T	Li16110	Li16210	Li16310	Li16410	
SB42T	Li21110	Li21210	Li21310	Li21410	
SBMMG					Li32510 Li32610
SB1TMG	Li17A10 Li17G10	Li17B10 Li17H10	Li17C10 Li17I10	Li17D10 Li17J10	
SB4TMG	Li20A10 Li20G10	Li20B10 Li20H10	Li20C10 Li20I10	Li20D10 Li20J10	
SB2TMGR	Li18A10 Li18G10	Li18B10 Li18H10	Li18C10 Li18I10	Li18D10 Li18J10	
SB2TMGL	Li19A10 Li19G10	Li19B10 Li19H10	Li19C10 Li19I10	Li19D10 Li19J10	
SB4MT					Li30510
SB3MT					Li34510
SBB22M					Li36010

B = Bticino frame  
L/H/P = Legrand / Hager / Peha frame

## Soft Touch CUSTOM RAL

The Soft Touch lets you choose the colour of the cover plates yourself from the RAL colour space. The possibilities that Soft Touch and Custom RAL offer are unlimited. By this, you can create a unique interior.

### SB11T

Li14111 (24 V), Li14211 (24 V + LED), Li14311 (250 V push button), Li14411 (250 V, mech. switch)

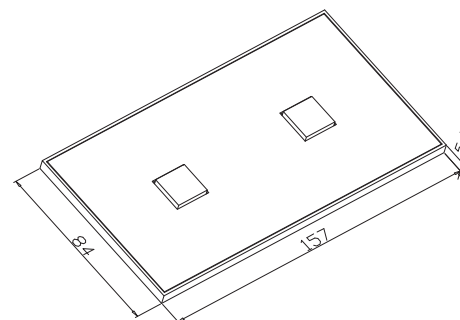
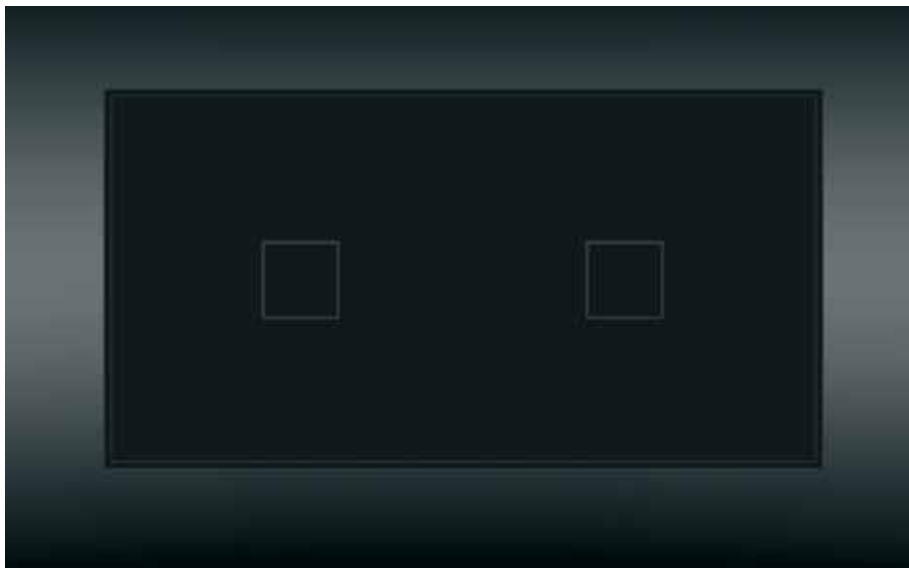

24 V pb: Max. 25 mA  
250 V pb: Max. 1 A  
250 V mech. switches: Max. 3 A

**Accessories:** Plaster kit

**Parts included:**

- frame
- cover plate
- mounting frame
- hook
- buttons

**Optional parts:**

- 250 V pb: protection frame, clamps
- 24 V + LED: connector, spacer, LED
- mech. switch: protection frame

Mech. switches : wall boxes (depth 65mm) included

IP  
41



### SBMK

Li33511 (Bticino frame), Li33611 (Legrand / Hager / Peha frame)

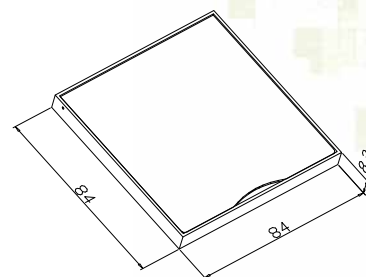
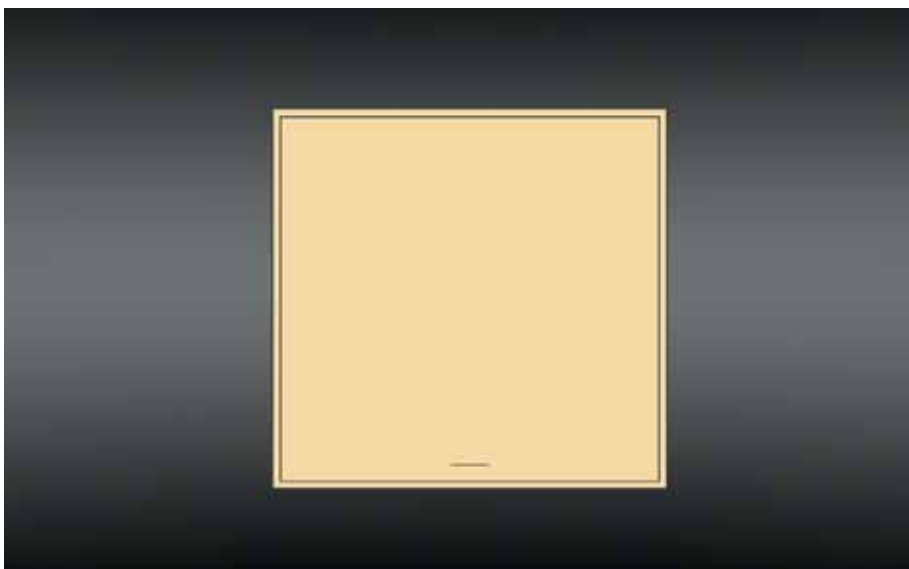

**Accessories:** Plaster kit

**Parts included:**

- frame
- cover plate
- mounting frame
- hook

For mounting max. 2 modules.

IP  
41



# Soft Touch Custom RAL

Available in:

Article group    24 V version    24 V + LED    250 V push button    250 V mech. switch    250 V modules

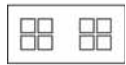

B  
L/H/P

B  
L/H/P

B  
L/H/P

B  
L/H/P

B  
L/H/P

B  
L/H/P

B  
L/H/P

B  
L/H/P

Article group	24 V version	24 V + LED	250 V push button	250 V mech. switch	250 V modules
SB1T	Li11111	Li11211	Li11311	Li11411	
SB2T	Li12111	Li12211	Li12311	Li12411	
SB4T	Li13111	Li13211	Li13311	Li13411	
SBMK					Li33511 Li33611
SBMG					Li31511 Li31611
SBQL					White Li37011 Blue Li38011
SBB2M					Li35011
SB11T	Li14111	Li14211	Li14311	Li14411	
SB22T	Li15111	Li15211	Li15311	Li15411	
SB44T	Li16111	Li16211	Li16311	Li16411	
SB42T	Li21111	Li21211	Li21311	Li21411	
SBMMG					Li32511 Li32611
SB1TMG	Li17A11 Li17G11	Li17B11 Li17H11	Li17C11 Li17I11	Li17D11 Li17J11	
SB4TMG	Li20A11 Li20G11	Li20B11 Li20H11	Li20C11 Li20I11	Li20D11 Li20J11	
SB2TMGR	Li18A11 Li18G11	Li18B11 Li18H11	Li18C11 Li18I11	Li18D11 Li18J11	
SB2TMGL	Li19A11 Li19G11	Li19B11 Li19H11	Li19C11 Li19I11	Li19D11 Li19J11	
SB4MT					Li30511
SB3MT					Li34511
SBB22M					Li36011

B = Bticino frame  
L/H/P = Legrand / Hager / Peha frame

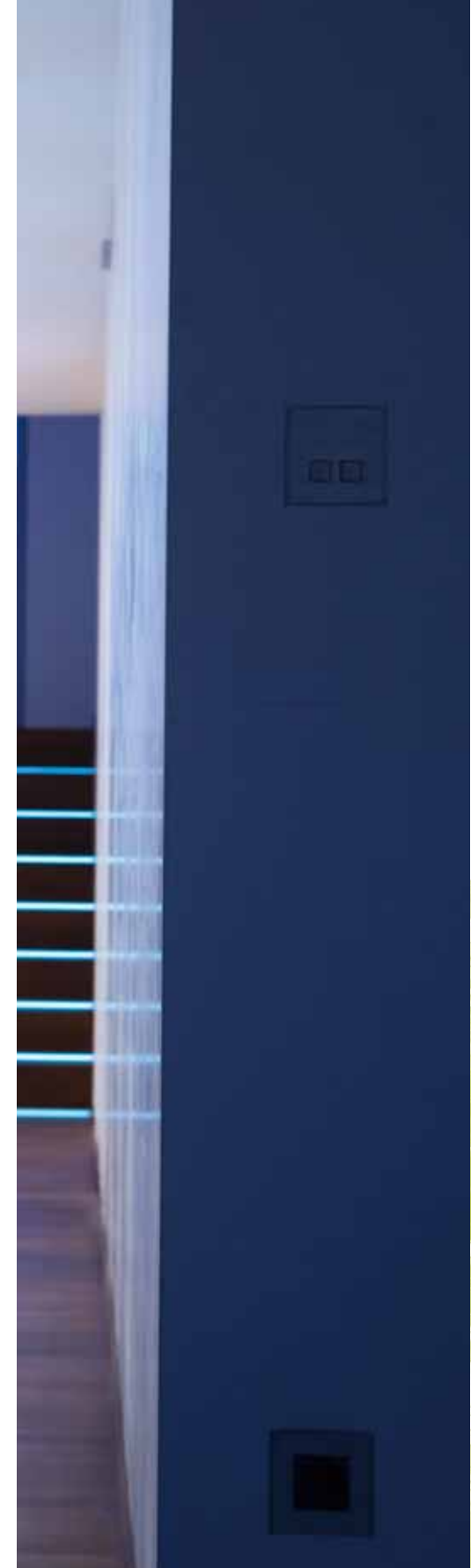

## Chromé

The chromé version is very special and remarkable. The white polished chromé is a shiny metal that reflects everything from the environment, just like a mirror.

### SB1T

Li11108 (24 V), Li11208 (24 V + LED), Li11308 (250 V push button), Li11408 (250 V, mech. switch)

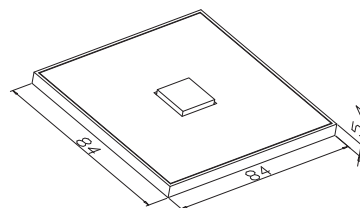
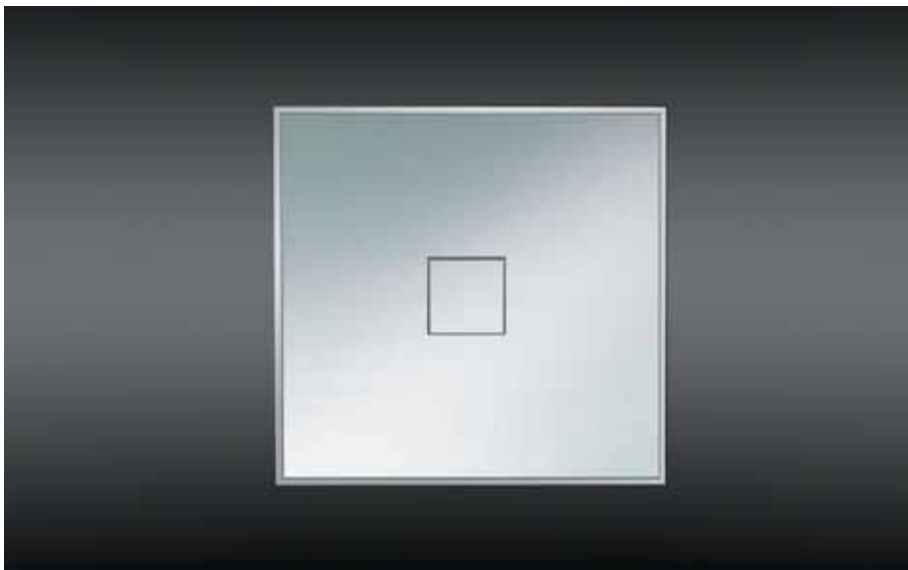

24 V pb: Max. 25 mA  
250 V pb: Max. 1 A  
250 V mech. switches: Max. 3 A

**Accessories:** Plaster kit

**Parts included:**

- frame
- cover plate
- mounting frame
- hook
- buttons

**Optional parts:**

- 250 V pb: protection frame, clamps
- 24 V + LED: connector, spacer, LED
- mech. switch: protection frame

Mech. switches : wall boxes (depth 65mm) included

IP  
41



### SBMMG

Li32508 (Bticino frame), Li32608 (Legrand / Hager / Peha frame)

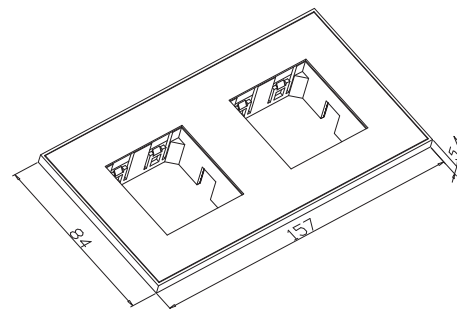
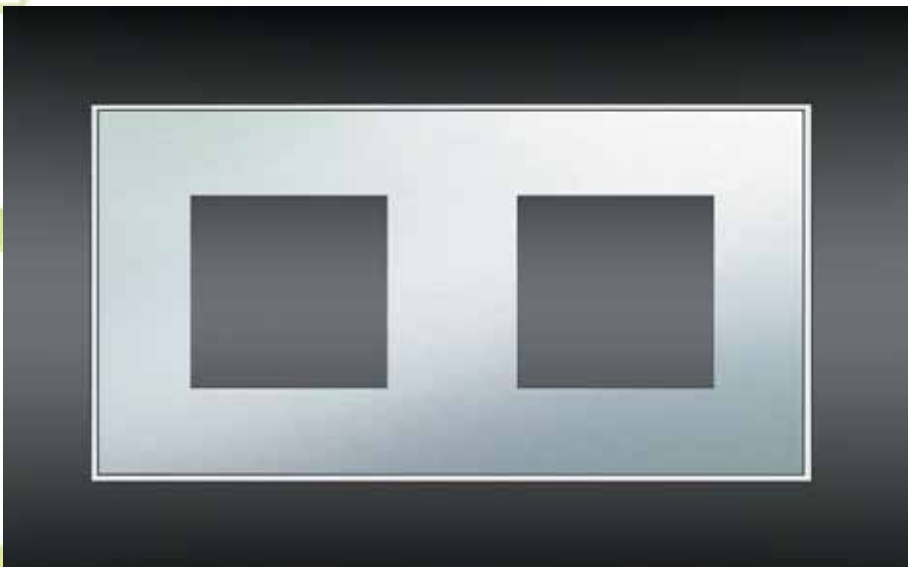

**Accessories:** Plaster kit

**Parts included:**

- frame
- cover plate
- mounting frame
- hook

For mounting max. 2 modules.



















IP  
41



# Chromé

Available in:

Article group    24 V version    24 V + LED    250 V push button    250 V mech. switch    250 V modules

Article group	24 V version	24 V + LED	250 V push button	250 V mech. switch	250 V modules	
	SB1T	Li11108	Li11208	Li11308	Li11408	
	SB2T	Li12108	Li12208	Li12308	Li12408	
	SB4T	Li13108	Li13208	Li13308	Li13408	
	B L/H/P SBMK					Li33508 Li33608
	B L/H/P SBMG					Li31508 Li31608
	SBQL					White Li37008 Blue Li38008
	SBB2M					Li35008
	SB11T	Li14108	Li14208	Li14308	Li14408	
	SB22T	Li15108	Li15208	Li15308	Li15408	
	SB44T	Li16108	Li16208	Li16308	Li16408	
	SB42T	Li20108	Li21208	Li21308	Li21408	
	B L/H/P SBMMG					Li32508 Li32608
	B L/H/P SB1TMG	Li17A08 Li17G08	Li17B08 Li17H08	Li17C08 Li17I08	Li17D08 Li17J08	
	B L/H/P SB4TMG	Li20A08 Li20G08	Li20B08 Li20H08	Li20C08 Li20I08	Li20D08 Li20J08	
	B L/H/P SB2TMGR	Li18A08 Li18G08	Li18B08 Li18H08	Li18C08 Li18I08	Li18D08 Li18J08	
	B L/H/P SB2TMGL	Li19A08 Li19G08	Li19B08 Li19H08	Li19C08 Li19I08	Li19D08 Li19J08	
	SB4MT					Li30508
	SB3MT					Li34508
	SBB22M					Li36008

B = Bticino frame  
L/H/P = Legrand / Hager / Peha frame





# SB<sub>4</sub>MT

New Product range for mounting of 4 Module wide productes



Lithoss presents the SB<sub>4</sub>MT. In this mounting frame you can place Bticino modules (Light, Living or LightTec range) up to 4 modules wide.

For this module, you need to use the 504 wall box from Bticino.

The SB<sub>4</sub>MT is available in all our standard finishing's.

## Article code

Li30501	SB <sub>4</sub> MT Stainless steel
Li30502	SB <sub>4</sub> MT RAL9010
Li30503	SB <sub>4</sub> MT Fusain
Li30504	SB <sub>4</sub> MT Bronze
Li30505	SB <sub>4</sub> MT Nickel Satiné
Li30506	SB <sub>4</sub> MT Laiton/Brass
Li30507	SB <sub>4</sub> MT Alu Grey
Li30508	SB <sub>4</sub> MT Chromé
Li30599	SB <sub>4</sub> MT Custom RAL
Li30510	SB <sub>4</sub> MT Soft Touch RAL9010
Li30511	SB <sub>4</sub> MT Soft Touch Custom RAL
Li30512	SB <sub>4</sub> MT Black Tulip

## Accessories

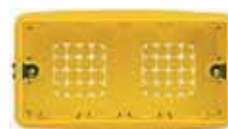

504E



PSN504E

## General Dimensions

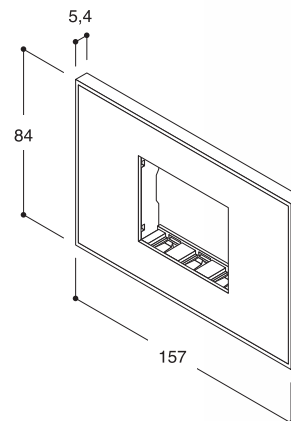



## 250 V switch

New mechanical switch

Lithoss can offer you now the mechanical switch **in the same design** as the push buttons. The single pole switches and changeover switches offer a lot of advantages. Especially on the renovation market this extension of our product range is very much appreciated.

### Advantages of our mechanical switch

- **Time & costs saving** for the end-users and the electrician.
- Easy to install: no more difficult micro modules necessary (except for our dimmers and timers).
- Is compatible with European wall boxes with screws at 60mm distance for single modules, with screws at 71mm for double modules with minimum depth of 50 mm. For SB4T, SB44T, SB42T or SB4TMG use wall boxes of 65mm depth (ref. RE1266).
- Standard cabling is enough.
- Fits perfectly within the current Lithoss Design.
- 3A/250V switches: maximum of 750W per lightgroup.
- Works independently from load: electronic ballast for fluorescent lighting, conventional light bulbs, 250V halogen light bulbs, economy light bulbs, ferromagnetic ballast, ...
- Also a momentary switch (push button) is available within the same construction class to handle dimming units with teleruptor module, time switches, ...
- All different combinations are possible with push button Lithoss products: single pole switches, single pole double throw , push buttons and dimming push buttons. Develop your own SB44T. In total there are more than 10.000 combinations possible.

# SQLite

New LED for orientation lighting



The SQLite is the new product in the Lithoss product range. The SQLite completes our product range with the existing orientation lights SBQLW and SBQLB.

The SQLite is equipped with LEDs. The difference with the SBQLW and SBQLB is that the light is diffused through the mat white cover and through the edges of the plastic frame.

## Avantages :

- Very low power consumption : less than 1 Watt!!
- Directly connectable to the mains (250V)  
(no transformer necessary).
- The SQLite can be mounted in a standard wall box and is very easy to install.
- Edgeglow
- Fluorescent
- Glows in the dark

## Dimensions :

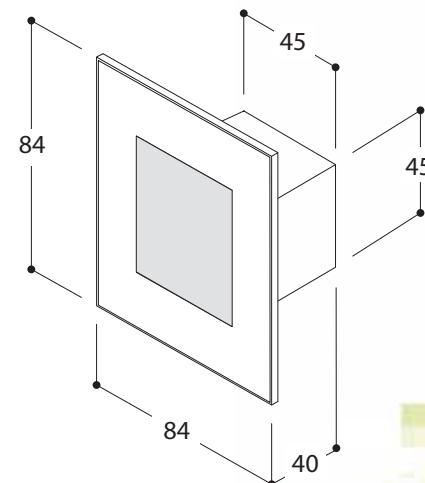

## Article code

Li40001	SQLite Stainless steel
Li40002	SQLite RAL9010
Li40003	SQLite Fusain
Li40004	SQLite Bronze
Li40005	SQLite Nickel Satiné
Li40006	SQLite Laiton/Brass
Li40007	SQLite Alu Grey
Li40008	SQLite Chromé
Li40099	SQLite Custom RAL
Li40010	SQLite Soft Touch RAL9010
Li40011	SQLite Soft Touch Custom RAL
Li40012	SQLite Black Tulip

**IMPORTANT:** The SQLite can only be switched ON and OFF with mechanical switches, NOT with micromodules.

# Articles et accessories

New module & adaptorplates

## Flat modules

Next to the Bticino, Legrand and Hager modules, Lithoss is also in the possibility to offer you the modules from the German brand PEHA. This module from the product range 'Module 45' fits perfectly in our Legrand/Hager mounting frame.

**Advantage :** The possibility to place these modules both **right as well as turned 90°**. The modules are flat with dimensions **45 x 45mm**. Because the modules are flat, they fit **perfectly** in our cover plate.

The product range offers sockets with computer and TV connections in the standard 3 colours : Alu grey, anthracite and white.



## Adaptorplates

It is perfectly possible to install the Lithoss products on a Bticino wall box 503E, 504E, 506L. The synthetic adaptorplates are delivered with enough screws to fix the plate on the wall box.

### Lithoss article code:

- Li44200 : Adaptorkit Bticino 503E (single frame)
- Li44201 : Adaptorkit Bticino 504E (single frame)
- Li44202 : Adaptorkit Bticino 506L (double frame)



# Article codes

## Flat modules

ARTICLE NUMBER	PRODUCT DESCRIPTION	COLOUR	MODULES
P512941	Outlet pin connection	Anthracite	2 modules
P414341	Outlet pin connection	White	2 modules
P516941	Outlet pin connection	Alu grey	2 modules
P512111	Outlet earth connection on side - 'SCHUKO'	Anthracite	2 modules
P414111	Outlet earth connection on side - 'SCHUKO'	White	2 modules
P516111	Outlet earth connection on side - 'SCHUKO'	Alu grey	2 modules
P525011	Connection for TV + Radio + Satellite	Anthracite	2 modules
P524911	Connection for TV + Radio + Satellite	White	2 modules
P525111	Connection for TV + Radio + Satellite	Alu grey	2 modules
P504013	Timer switch	Anthracite	2 modules
P503913	Timer switch	White	2 modules
P504113	Timer switch	Alu grey	2 modules
P500213	Programmable Thermostat - day/week	Anthracite	2 modules
P500113	Programmable Thermostat - day/week	White	2 modules
P500313	Programmable Thermostat - day/week	Alu grey	2 modules
P500613	Roll-down switch	Anthracite	2 modules
P500513	Roll-down switch	White	2 modules
P500713	Roll-down switch	Alu grey	2 modules
P504613	Movement detector	Anthracite	2 modules
P504513	Movement detector	White	2 modules
P504713	Movement detector	Alu grey	2 modules
P512011	Blank module	Anthracite	1 module
P416311	Blank module	White	1 module
P516011	Blank module	Alu grey	1 module
P511911	Blank module	Anthracite	2 modules
P416211	Blank module	White	2 modules
P515911	Blank module	Alu grey	2 modules

# Wireless switching

## Wireless transmitters & receivers



### General description

The wireless transmitters and receivers work perfectly in combination with the Lithoss pushbuttons and switches. The miniature transmitter can be fitted into a wall box behind the Lithoss buttons easily. No further wiring to the switches is needed. The receivers exist in various forms and capacities and are available with teleruptor timer and dimmer functions. The radio frequency (868,3 MHz) has been set for interference-free operation.

### Technical Specifications

Radio frequency	868,3 MHz
Transmission range	More then 50m in open air Up to 150m with antenna
Max. Load	500W - 3000VA (See product description)

### Article code







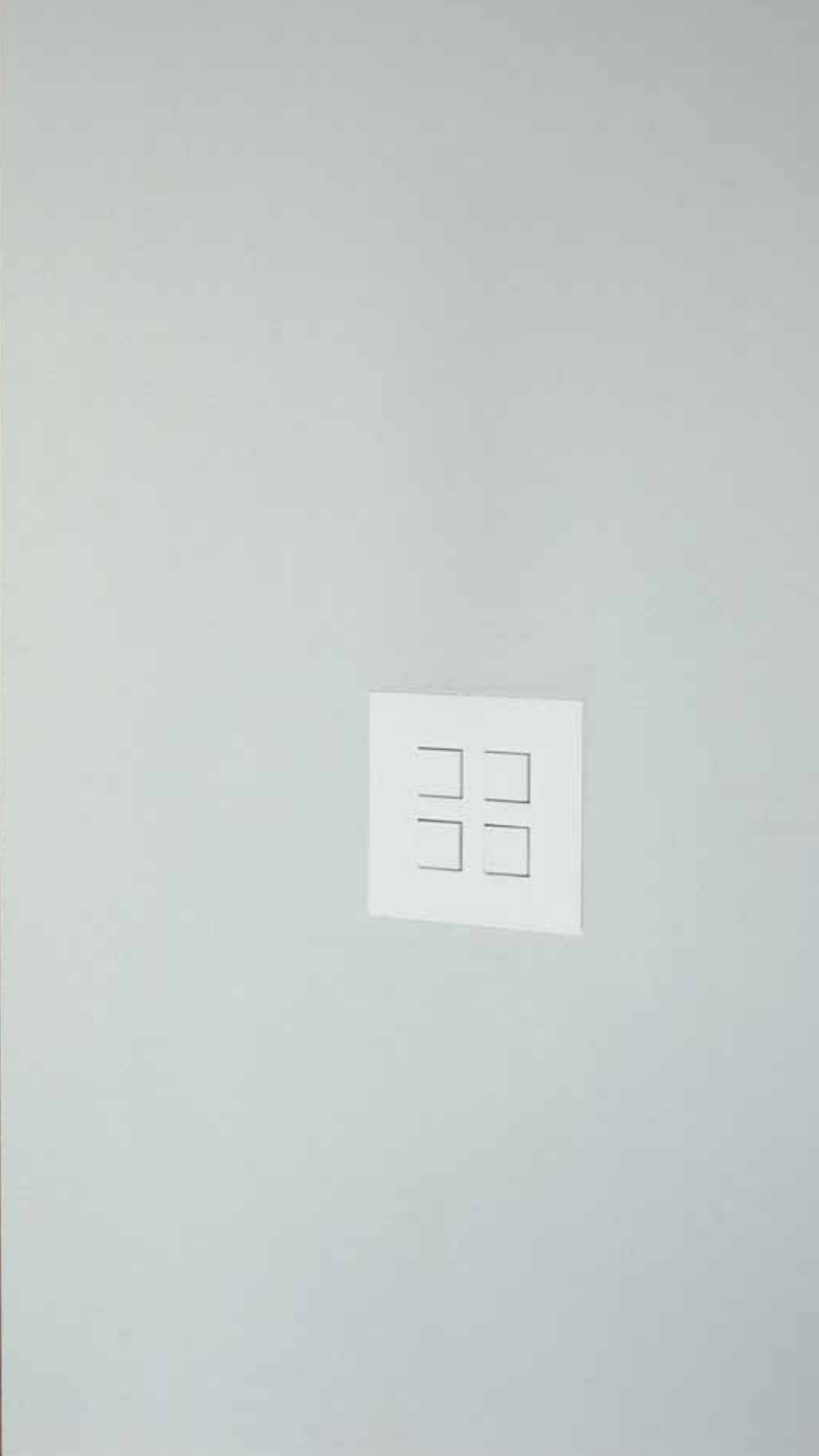

















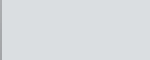



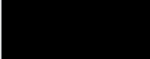

LI TXL 868 B02  
LI TXL 868 A02  
LI RRL 868 S01  
LI RGL 868 A02  
LI DMM 868 A08  
LI RCD 868 A04N  
LI RCD 868 A01  
LI RCD 868 M04  
LI DMM 868 A01

### Product description

Transmitter miniature (bat.) for wall box - 2 channels  
Transmitter 230VAC for wall box - 2 channels  
Receiver for wall box 1000VA (switch & pushbutton) - 1 channel  
Receiver for ceiling 2000VA - 2 channels  
Dimmer for ceiling 500W - 1 channel  
Receiver for DIN-rail 3000VA - 4 channels - Master  
Receiver for DIN-rail 3000VA - 1 channel - Master  
Receiver for DIN-rail 3000VA - 4 channels - Slave  
Dimmer for DIN-rail 500W - 1 channel



# ORDER FORM

	Quantity	24 V version	24 V + LED	250 V push button	250 V mech. switch	250 V modules	Colour code	Finishings
							01 = Stainless steel	
							02 = RAL9010	
							03 = Fusain	
	B						04 = Bronze	
	L/H/P						05 = Nickel Satiné	
	B						06 = Brass	
	L/H/P						07 = Alu Grey	
							08 = Chromé	
							99 = Custom RAL	
							10 = Soft Touch RAL9010	
							11 = Soft Touch Custom RAL	
	B						12 = Black Tulip	
	L/H/P							
	B							
	L/H/P							
	B							
	L/H/P							
	B							
	L/H/P							
